

# ESD Protection Diodes

Low Capacitance Bidirectional ESD and Transient Voltage Protection

SD0505D52L SOD523



## Description

The SD0505D52L is designed to protect voltage sensitive components from ESD and transient voltage events. Excellent clamping capability, low leakage, and fast response time, make these parts ideal for ESD protection on designs where board space is at a premium.

## Pinout and Functional Block Diagram

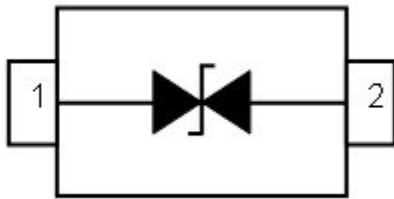

This device has been specifically designed to protect sensitive components which are connected to data and transmission lines from overvoltage caused by ESD (electrostatic discharge), CDE (Cable Discharge Events), and EFT (electrical fast transients).

## Applications

- Cell Phone Handsets and Accessories
- Notebooks, Desktops, and Servers
- High Speed Line :USB 1.0 / 2.0, VGA, DVI, SDI
- Portable Instrumentation
- Protection TV
- Serial and Parallel Ports
- Peripherals

## Features

- ESD per IEC 61000-4-2 ± 30 kV (Contact)
- ESD per IEC 61000-4-2 ± 30 kV (Air)
- IEC61000-4-4 (EFT) 40 A (5 / 50 ns)
- Peak Power Dissipation: 75 W (8 / 20 μs)
- Protects One I/O Line
- Low Clamping Voltage
- Low Leakage Current
- Low Capacitance
- High Temperature to Reflow Soldering Guaranteed: 260 °C / 10 sec
- Flammability Rating: UL 94 V-0
- Halogen Free and RoHS Compliant

## Order Information

| Type            | Package | Marking Code | Reel Size | Quantity/Reel | Note                                    |
|-----------------|---------|--------------|-----------|---------------|-----------------------------------------|
| SD0505D52L - T3 | SOD523  | 5C∞          | 7" T&R    | 3000 PCS      | Empty pocket between sprocket holes.    |
| SD0505D52L - T8 | SOD523  | 5C∞          | 7" T&R    | 8000 PCS      | No empty pocket between sprocket holes. |

## Limiting Values

(T<sub>A</sub> = 25 °C, unless otherwise specified)

| Symbol           | Parameter                       | Conditions                       | Min | Max | Unit |
|------------------|---------------------------------|----------------------------------|-----|-----|------|
| V <sub>ESD</sub> | Electrostatic Discharge Voltage | IEC 61000-4-2; Contact Discharge | -   | ±30 | kV   |
|                  |                                 | IEC 61000-4-2; Air Discharge     | -   | ±30 | kV   |
| P <sub>PP</sub>  | Peak Pulse Power (8 / 20 μs)    | -                                |     | 75  | W    |
| T <sub>A</sub>   | Operating Temperature Range     | -                                | -40 | 150 | °C   |
| T <sub>stg</sub> | Storage Temperature Range       | -                                | -55 | 150 | °C   |

# ESD Protection Diodes

Low Capacitance Bidirectional ESD and Transient Voltage Protection

SD0505D52L SOD523

## Package Dimensions - SOD523

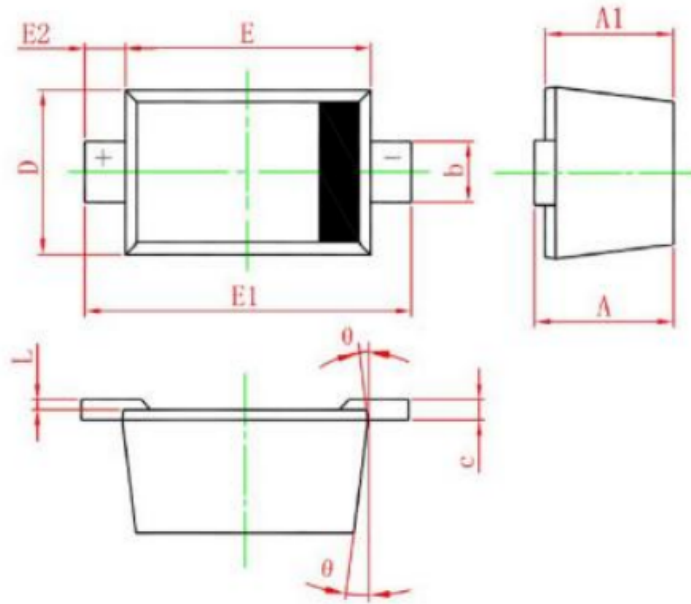

| Symbol | Millimeters |      | Inches    |       |
|--------|-------------|------|-----------|-------|
|        | Min.        | Max. | Min.      | Max.  |
| A      | 0.51        | 0.77 | 0.020     | 0.031 |
| A1     | 0.50        | 0.70 | 0.020     | 0.028 |
| b      | 0.25        | 0.35 | 0.010     | 0.014 |
| c      | 0.08        | 0.15 | 0.003     | 0.006 |
| D      | 0.70        | 0.90 | 0.028     | 0.035 |
| E      | 1.10        | 1.30 | 0.043     | 0.051 |
| E1     | 1.50        | 1.70 | 0.059     | 0.067 |
| E2     | 0.20 REF    |      | 0.008 REF |       |
| L      | 0.01        | 0.07 | 0.001     | 0.003 |
| φ      | 7 ° REF     |      | 7 ° REF   |       |

# ESD Protection Diodes

Low Capacitance Bidirectional ESD and Transient Voltage Protection

SD0505D52L SOD523

## Electrical Characteristics

(T<sub>A</sub> = 25 °C, unless otherwise specified)

| Symbol           | Parameter                 | Conditions                                        | Min | Typ | Max | Unit |
|------------------|---------------------------|---------------------------------------------------|-----|-----|-----|------|
| V <sub>RWM</sub> | Reverse Working Voltage   | -                                                 | -   | -   | 5.0 | V    |
| V <sub>BR</sub>  | Reverse Breakdown Voltage | I <sub>T</sub> = 1 mA                             | 5.6 | -   | 9.0 | V    |
| I <sub>R</sub>   | Reverse Leakage Current   | V <sub>RWM</sub> = 5 V                            | -   | -   | 1.0 | μA   |
| V <sub>C</sub>   | Clamping Voltage          | I <sub>PP</sub> = 1 A, t <sub>p</sub> = 8 / 20 μs | -   | -   | 9.8 | V    |
| V <sub>C</sub>   | Clamping Voltage          | I <sub>PP</sub> = 5 A, t <sub>p</sub> = 8 / 20 μs | -   | -   | 15  | V    |
| C <sub>J</sub>   | Junction Capacitance      | V <sub>R</sub> = 0 V, Measured at 1 MHz           | -   | -   | 15  | pF   |

# ESD Protection Diodes

Low Capacitance Bidirectional ESD and Transient Voltage Protection

SD0505D52L SOD523

## Performance Curve for Reference

( $T_A=25\text{ }^\circ\text{C}$  unless otherwise noted)

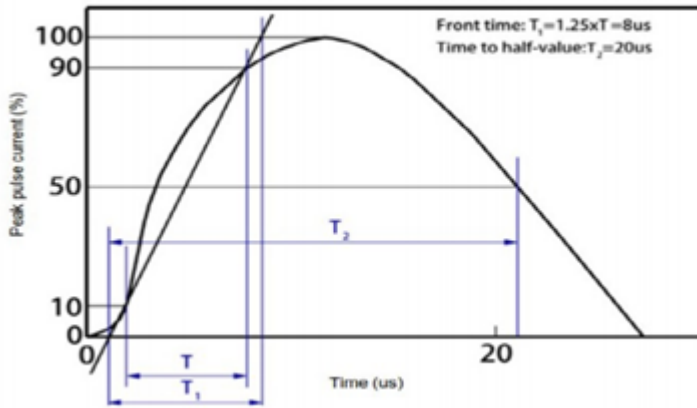

FIGURE 1

8 / 20  $\mu\text{s}$  Waveform Per IEC61000-4-5

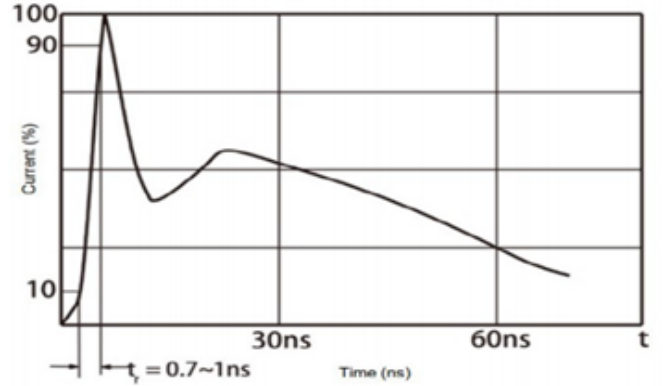

FIGURE 2

Contact Discharge Current Waveform Per IEC 61000-4-2

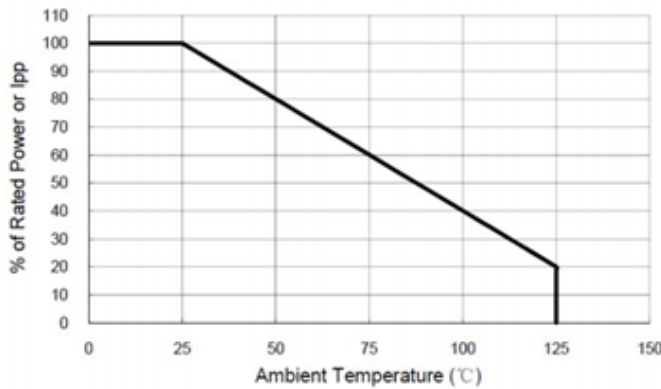

FIGURE 3

Power Derating Curve

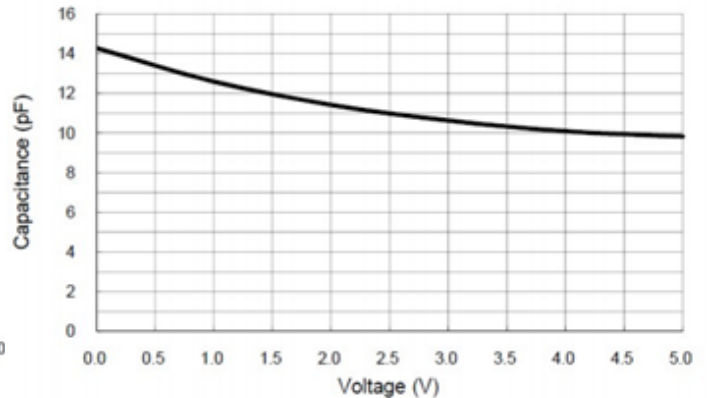

FIGURE 4

Voltage VS. Capacitance

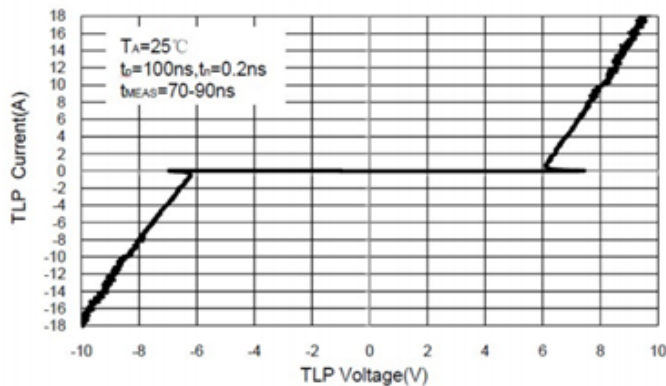

FIGURE 5

Transmission Line Pulsing (TLP) Measurement

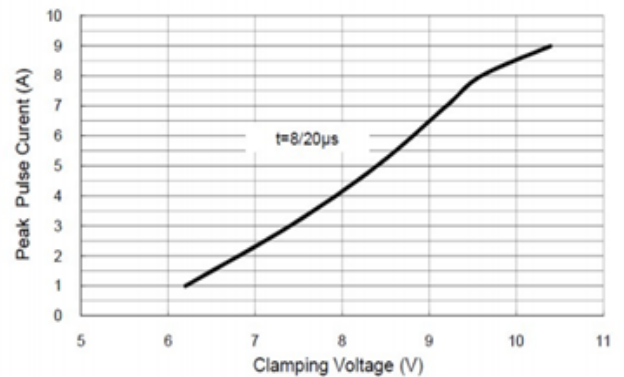

FIGURE 6

Clamping Voltage VS. Peak Pulse Current

# ESD Protection Diodes

Low Capacitance Bidirectional ESD and Transient Voltage Protection

SD0505D52L SOD523

## Soldering Parameters

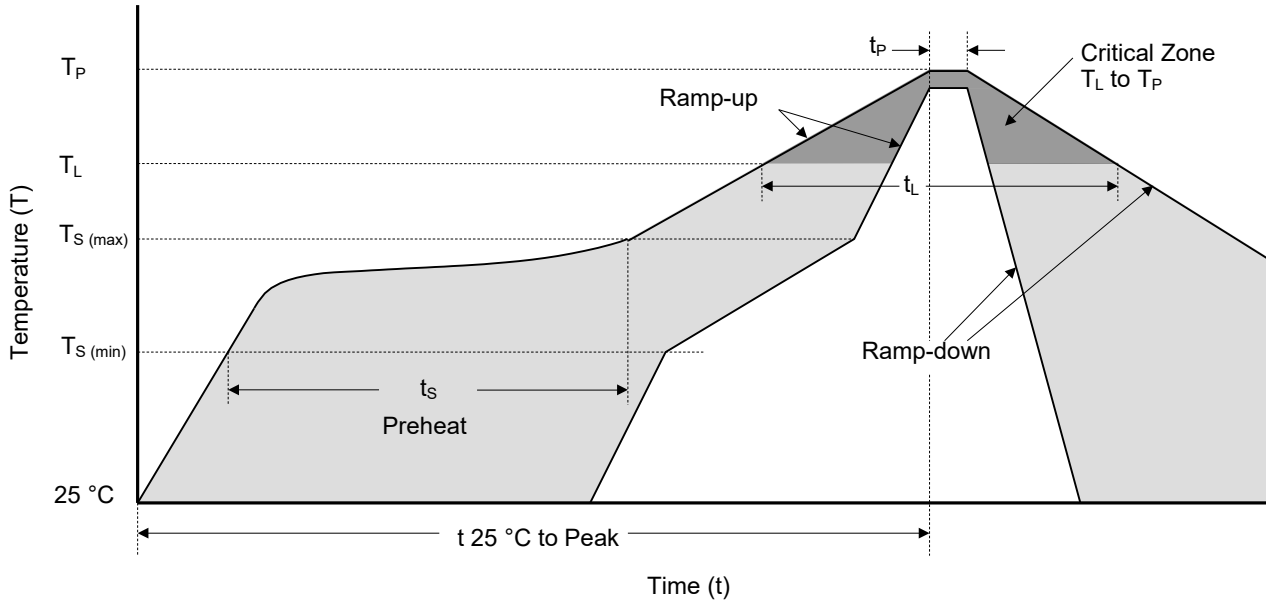

Reflowing Condition

| Reflow Soldering Parameters                              |                                   | Lead-Free Assembly      |
|----------------------------------------------------------|-----------------------------------|-------------------------|
| Pre-heat                                                 | Temperature Min ( $T_{S (min)}$ ) | 150 °C                  |
|                                                          | Temperature Max ( $T_{S (max)}$ ) | 200 °C                  |
|                                                          | Time (min to max) ( $t_s$ )       | 60 ~ 120 seconds        |
| Average Ramp Up Rate (Liquidus Temp ( $T_L$ ) to Peak)   |                                   | 3 °C / second max.      |
| $T_S (max)$ to $T_L$ Ramp-up Rate                        |                                   | 3 °C / second max.      |
| Reflow                                                   | Temperature ( $T_L$ ) (Liquidus)  | 217 °C                  |
|                                                          | Time (min to max) ( $t_L$ )       | 60 ~ 150 seconds        |
| Peak Temperature ( $T_P$ )                               |                                   | 260 <sup>+0/-5</sup> °C |
| Time of within 5 °C of Actual Peak Temperature ( $t_p$ ) |                                   | 20 ~ 40 seconds         |
| Ramp-down Rate                                           |                                   | 6 °C / second max.      |
| Time from 25 °C to Peak Temperature                      |                                   | 8 Minutes max.          |
| Do Not Exceed                                            |                                   | 260 °C                  |



# ATTENTION

## Usage

1. TVS must be operated in the specified ambient temp.
2. Do not clean the TVS with strong polar solvent such as ketone, esters, benzene and halogenated hydrocarbon, to avoid damaging the encapsulating layer.
3. Please do not apply severe vibration, shock or pressure to TVS, to avoid element cracking.

## Replacement

1. If TVS is visually damaged, please replace it.
2. TVS is a non-repairable product. For safety sake, please use equivalent TVS for replacement.

## Storage

1. Storage Temp. Range: (-55 to 150) °C.
2. Do not store the TVS at the high temp., high humidity or corrosive gas environment, to avoid influencing the solder-ability of the lead wires. The product shall be used up within 1 year after receiving the goods.

## Environmental Conditions

1. TVS should not be exposed to the open air, nor direct sunshine.
2. TVS should avoid rain, water vapor or other condition of high temp. and high humidity.
3. TVS should avoid sand dust, salt mist, or other harmful gases.

## Max. Typical Capacitance of TVS

The typical capacitance of TVS is listed in the specifications. Designers may refer to it when designing TVS in High frequency circuit.

## Installation Mechanical Stress



























































































































































1. Do not knock TVS when installing, to avoid mechanical damage.
2. Please do not apply severe vibration, shock or pressure to TVS, to avoid surface resin or element cracking.

# ESD Protection Diodes

Low Capacitance Bidirectional ESD and Transient Voltage Protection

SD0505D52L SOD523

## Circuit Diagram

|                                                                                     |         |                                                                                     |         |                                                                                     |         |                                                                                     |         |                                                                                     |            |                                                                                     |         |                                                                                     |            |                                                                                     |         |                                                                                     |         |                                                                                     |         |                                                                                     |            |                                                                                     |         |                                                                                    |            |                                                                                    |         |                                                                                   |         |                                                                                   |         |                                                                                   |             |                                                                                   |         |                                                                                   |            |                                                                                   |         |                                                                                   |         |                                                                                   |         |                                                                                     |         |                                                                                     |         |                                                                                     |         |                                                                                     |         |                                                                                     |         |                                                                                     |         |                                                                                     |         |                                                                                     |         |                                                                                     |         |                                                                                     |         |                                                                                     |         |                                                                                     |         |                                                                                    |         |                                                                                    |         |                                                                                   |         |                                                                                   |         |                                                                                   |         |                                                                                   |         |                                                                                   |         |                                                                                   |         |                                                                                   |         |                                                                                   |         |                                                                                     |         |                                                                                     |         |                                                                                     |         |                                                                                     |         |                                                                                     |         |                                                                                     |         |                                                                                     |         |                                                                                     |         |                                                                                     |         |                                                                                     |         |                                                                                     |         |                                                                                     |         |                                                                                    |         |                                                                                    |         |                                                                                   |         |                                                                                   |         |                                                                                   |         |                                                                                   |         |                                                                                   |         |                                                                                   |         |                                                                                   |         |                                                                                   |         |                                                                                       |         |                                                                                       |         |                                                                                       |         |                                                                                       |         |                                                                                       |         |                                                                                       |         |                                                                                       |         |                                                                                       |         |                                                                                       |         |                                                                                       |         |                                                                                       |           |                                                                                       |         |                                                                                      |        |                                                                                      |         |                                                                                     |        |                                                                                     |         |                                                                                     |        |                                                                                     |         |                                                                                     |        |                                                                                     |         |                                                                                     |        |                                                                                     |         |                                                                                       |         |                                                                                       |         |                                                                                       |         |                                                                                       |         |                                                                                       |         |                                                                                       |         |                                                                                       |         |                                                                                       |         |                                                                                       |         |                                                                                       |         |                                                                                       |         |                                                                                       |         |                                                                                      |         |                                                                                      |         |                                                                                     |         |                                                                                     |         |                                                                                     |         |                                                                                     |         |                                                                                     |         |                                                                                     |         |                                                                                     |         |                                                                                     |         |                                                                                       |         |                                                                                       |         |                                                                                       |         |                                                                                       |         |                                                                                       |         |                                                                                       |         |                                                                                       |         |                                                                                       |         |                                                                                       |         |                                                                                       |         |                                                                                       |         |                                                                                       |         |                                                                                      |         |                                                                                      |         |                                                                                     |         |                                                                                     |         |                                                                                     |         |                                                                                     |         |                                                                                     |         |                                                                                     |         |                                                                                     |         |                                                                                     |         |                                                                                       |         |                                                                                       |         |                                                                                       |         |                                                                                       |         |                                                                                       |         |                                                                                       |         |                                                                                       |         |                                                                                       |         |                                                                                       |         |                                                                                       |         |                                                                                       |         |                                                                                       |         |                                                                                      |         |                                                                                      |         |                                                                                     |         |                                                                                     |         |                                                                                     |         |                                                                                     |         |                                                                                     |         |                                                                                     |         |                                                                                     |         |                                                                                     |         |                                                                                       |        |                                                                                       |         |                                                                                       |        |                                                                                       |         |                                                                                       |        |                                                                                       |         |                                                                                       |        |                                                                                       |         |                                                                                       |        |                                                                                       |         |                                                                                       |        |                                                                                       |         |                                                                                      |        |                                                                                      |         |                                                                                     |        |                                                                                     |         |                                                                                     |        |                                                                                     |         |                                                                                     |        |                                                                                     |         |                                                                                     |        |                                                                                     |         |                                                                                       |         |                                                                                       |         |                                                                                       |         |                                                                                       |         |                                                                                       |         |                                                                                       |         |                                                                                       |         |                                                                                       |         |                                                                                       |         |                                                                                       |         |                                                                                       |         |                                                                                       |         |                                                                                      |         |                                                                                      |         |                                                                                     |         |                                                                                     |         |                                                                                     |         |                                                                                     |         |                                                                                     |         |                                                                                     |         |                                                                                     |         |                                                                                     |         |                                                                                       |         |                                                                                       |         |                                                                                       |         |                                                                                       |         |                                                                                       |         |                                                                                       |         |                                                                                       |         |                                                                                       |         |                                                                                       |         |                                                                                       |         |                                                                                       |         |                                                                                       |         |                                                                                      |         |                                                                                      |         |                                                                                     |         |                                                                                     |         |                                                                                     |         |                                                                                     |         |                                                                                     |         |                                                                                     |         |                                                                                     |         |                                                                                     |         |                                                                                       |         |                                                                                       |         |                                                                                       |         |                                                                                       |         |                                                                                       |         |                                                                                       |         |                                                                                       |         |                                                                                       |         |                                                                                       |         |                                                                                       |         |                                                                                       |         |                                                                                       |         |                                                                                      |         |                                                                                      |         |                                                                                     |         |                                                                                     |         |                                                                                     |         |                                                                                     |         |                                                                                     |         |                                                                                     |         |                                                                                     |         |                                                                                     |         |                                                                                       |         |                                                                                       |         |                                                                                       |         |                                                                                       |         |                                                                                       |         |                                                                                       |         |                                                                                       |         |                                                                                       |         |                                                                                       |         |                                                                                       |         |                                                                                       |         |                                                                                       |         |                                                                                      |         |                                                                                      |         |                                                                                     |         |  |
|-------------------------------------------------------------------------------------|---------|-------------------------------------------------------------------------------------|---------|-------------------------------------------------------------------------------------|---------|-------------------------------------------------------------------------------------|---------|-------------------------------------------------------------------------------------|------------|-------------------------------------------------------------------------------------|---------|-------------------------------------------------------------------------------------|------------|-------------------------------------------------------------------------------------|---------|-------------------------------------------------------------------------------------|---------|-------------------------------------------------------------------------------------|---------|-------------------------------------------------------------------------------------|------------|-------------------------------------------------------------------------------------|---------|------------------------------------------------------------------------------------|------------|------------------------------------------------------------------------------------|---------|-----------------------------------------------------------------------------------|---------|-----------------------------------------------------------------------------------|---------|-----------------------------------------------------------------------------------|-------------|-----------------------------------------------------------------------------------|---------|-----------------------------------------------------------------------------------|------------|-----------------------------------------------------------------------------------|---------|-----------------------------------------------------------------------------------|---------|-----------------------------------------------------------------------------------|---------|-------------------------------------------------------------------------------------|---------|-------------------------------------------------------------------------------------|---------|-------------------------------------------------------------------------------------|---------|-------------------------------------------------------------------------------------|---------|-------------------------------------------------------------------------------------|---------|-------------------------------------------------------------------------------------|---------|-------------------------------------------------------------------------------------|---------|-------------------------------------------------------------------------------------|---------|-------------------------------------------------------------------------------------|---------|-------------------------------------------------------------------------------------|---------|-------------------------------------------------------------------------------------|---------|-------------------------------------------------------------------------------------|---------|------------------------------------------------------------------------------------|---------|------------------------------------------------------------------------------------|---------|-----------------------------------------------------------------------------------|---------|-----------------------------------------------------------------------------------|---------|-----------------------------------------------------------------------------------|---------|-----------------------------------------------------------------------------------|---------|-----------------------------------------------------------------------------------|---------|-----------------------------------------------------------------------------------|---------|-----------------------------------------------------------------------------------|---------|-----------------------------------------------------------------------------------|---------|-------------------------------------------------------------------------------------|---------|-------------------------------------------------------------------------------------|---------|-------------------------------------------------------------------------------------|---------|-------------------------------------------------------------------------------------|---------|-------------------------------------------------------------------------------------|---------|-------------------------------------------------------------------------------------|---------|-------------------------------------------------------------------------------------|---------|-------------------------------------------------------------------------------------|---------|-------------------------------------------------------------------------------------|---------|-------------------------------------------------------------------------------------|---------|-------------------------------------------------------------------------------------|---------|-------------------------------------------------------------------------------------|---------|------------------------------------------------------------------------------------|---------|------------------------------------------------------------------------------------|---------|-----------------------------------------------------------------------------------|---------|-----------------------------------------------------------------------------------|---------|-----------------------------------------------------------------------------------|---------|-----------------------------------------------------------------------------------|---------|-----------------------------------------------------------------------------------|---------|-----------------------------------------------------------------------------------|---------|-----------------------------------------------------------------------------------|---------|-----------------------------------------------------------------------------------|---------|---------------------------------------------------------------------------------------|---------|---------------------------------------------------------------------------------------|---------|---------------------------------------------------------------------------------------|---------|---------------------------------------------------------------------------------------|---------|---------------------------------------------------------------------------------------|---------|---------------------------------------------------------------------------------------|---------|---------------------------------------------------------------------------------------|---------|---------------------------------------------------------------------------------------|---------|---------------------------------------------------------------------------------------|---------|---------------------------------------------------------------------------------------|---------|---------------------------------------------------------------------------------------|-----------|---------------------------------------------------------------------------------------|---------|--------------------------------------------------------------------------------------|--------|--------------------------------------------------------------------------------------|---------|-------------------------------------------------------------------------------------|--------|-------------------------------------------------------------------------------------|---------|-------------------------------------------------------------------------------------|--------|-------------------------------------------------------------------------------------|---------|-------------------------------------------------------------------------------------|--------|-------------------------------------------------------------------------------------|---------|-------------------------------------------------------------------------------------|--------|-------------------------------------------------------------------------------------|---------|---------------------------------------------------------------------------------------|---------|---------------------------------------------------------------------------------------|---------|---------------------------------------------------------------------------------------|---------|---------------------------------------------------------------------------------------|---------|---------------------------------------------------------------------------------------|---------|---------------------------------------------------------------------------------------|---------|---------------------------------------------------------------------------------------|---------|---------------------------------------------------------------------------------------|---------|---------------------------------------------------------------------------------------|---------|---------------------------------------------------------------------------------------|---------|---------------------------------------------------------------------------------------|---------|---------------------------------------------------------------------------------------|---------|--------------------------------------------------------------------------------------|---------|--------------------------------------------------------------------------------------|---------|-------------------------------------------------------------------------------------|---------|-------------------------------------------------------------------------------------|---------|-------------------------------------------------------------------------------------|---------|-------------------------------------------------------------------------------------|---------|-------------------------------------------------------------------------------------|---------|-------------------------------------------------------------------------------------|---------|-------------------------------------------------------------------------------------|---------|-------------------------------------------------------------------------------------|---------|---------------------------------------------------------------------------------------|---------|---------------------------------------------------------------------------------------|---------|---------------------------------------------------------------------------------------|---------|---------------------------------------------------------------------------------------|---------|---------------------------------------------------------------------------------------|---------|---------------------------------------------------------------------------------------|---------|---------------------------------------------------------------------------------------|---------|---------------------------------------------------------------------------------------|---------|---------------------------------------------------------------------------------------|---------|---------------------------------------------------------------------------------------|---------|---------------------------------------------------------------------------------------|---------|---------------------------------------------------------------------------------------|---------|--------------------------------------------------------------------------------------|---------|--------------------------------------------------------------------------------------|---------|-------------------------------------------------------------------------------------|---------|-------------------------------------------------------------------------------------|---------|-------------------------------------------------------------------------------------|---------|-------------------------------------------------------------------------------------|---------|-------------------------------------------------------------------------------------|---------|-------------------------------------------------------------------------------------|---------|-------------------------------------------------------------------------------------|---------|-------------------------------------------------------------------------------------|---------|---------------------------------------------------------------------------------------|---------|---------------------------------------------------------------------------------------|---------|---------------------------------------------------------------------------------------|---------|---------------------------------------------------------------------------------------|---------|---------------------------------------------------------------------------------------|---------|---------------------------------------------------------------------------------------|---------|---------------------------------------------------------------------------------------|---------|---------------------------------------------------------------------------------------|---------|---------------------------------------------------------------------------------------|---------|---------------------------------------------------------------------------------------|---------|---------------------------------------------------------------------------------------|---------|---------------------------------------------------------------------------------------|---------|--------------------------------------------------------------------------------------|---------|--------------------------------------------------------------------------------------|---------|-------------------------------------------------------------------------------------|---------|-------------------------------------------------------------------------------------|---------|-------------------------------------------------------------------------------------|---------|-------------------------------------------------------------------------------------|---------|-------------------------------------------------------------------------------------|---------|-------------------------------------------------------------------------------------|---------|-------------------------------------------------------------------------------------|---------|-------------------------------------------------------------------------------------|---------|---------------------------------------------------------------------------------------|--------|---------------------------------------------------------------------------------------|---------|---------------------------------------------------------------------------------------|--------|---------------------------------------------------------------------------------------|---------|---------------------------------------------------------------------------------------|--------|---------------------------------------------------------------------------------------|---------|---------------------------------------------------------------------------------------|--------|---------------------------------------------------------------------------------------|---------|---------------------------------------------------------------------------------------|--------|---------------------------------------------------------------------------------------|---------|---------------------------------------------------------------------------------------|--------|---------------------------------------------------------------------------------------|---------|--------------------------------------------------------------------------------------|--------|--------------------------------------------------------------------------------------|---------|-------------------------------------------------------------------------------------|--------|-------------------------------------------------------------------------------------|---------|-------------------------------------------------------------------------------------|--------|-------------------------------------------------------------------------------------|---------|-------------------------------------------------------------------------------------|--------|-------------------------------------------------------------------------------------|---------|-------------------------------------------------------------------------------------|--------|-------------------------------------------------------------------------------------|---------|---------------------------------------------------------------------------------------|---------|---------------------------------------------------------------------------------------|---------|---------------------------------------------------------------------------------------|---------|---------------------------------------------------------------------------------------|---------|---------------------------------------------------------------------------------------|---------|---------------------------------------------------------------------------------------|---------|---------------------------------------------------------------------------------------|---------|---------------------------------------------------------------------------------------|---------|---------------------------------------------------------------------------------------|---------|---------------------------------------------------------------------------------------|---------|---------------------------------------------------------------------------------------|---------|---------------------------------------------------------------------------------------|---------|--------------------------------------------------------------------------------------|---------|--------------------------------------------------------------------------------------|---------|-------------------------------------------------------------------------------------|---------|-------------------------------------------------------------------------------------|---------|-------------------------------------------------------------------------------------|---------|-------------------------------------------------------------------------------------|---------|-------------------------------------------------------------------------------------|---------|-------------------------------------------------------------------------------------|---------|-------------------------------------------------------------------------------------|---------|-------------------------------------------------------------------------------------|---------|---------------------------------------------------------------------------------------|---------|---------------------------------------------------------------------------------------|---------|---------------------------------------------------------------------------------------|---------|---------------------------------------------------------------------------------------|---------|---------------------------------------------------------------------------------------|---------|---------------------------------------------------------------------------------------|---------|---------------------------------------------------------------------------------------|---------|---------------------------------------------------------------------------------------|---------|---------------------------------------------------------------------------------------|---------|---------------------------------------------------------------------------------------|---------|---------------------------------------------------------------------------------------|---------|---------------------------------------------------------------------------------------|---------|--------------------------------------------------------------------------------------|---------|--------------------------------------------------------------------------------------|---------|-------------------------------------------------------------------------------------|---------|-------------------------------------------------------------------------------------|---------|-------------------------------------------------------------------------------------|---------|-------------------------------------------------------------------------------------|---------|-------------------------------------------------------------------------------------|---------|-------------------------------------------------------------------------------------|---------|-------------------------------------------------------------------------------------|---------|-------------------------------------------------------------------------------------|---------|---------------------------------------------------------------------------------------|---------|---------------------------------------------------------------------------------------|---------|---------------------------------------------------------------------------------------|---------|---------------------------------------------------------------------------------------|---------|---------------------------------------------------------------------------------------|---------|---------------------------------------------------------------------------------------|---------|---------------------------------------------------------------------------------------|---------|---------------------------------------------------------------------------------------|---------|---------------------------------------------------------------------------------------|---------|---------------------------------------------------------------------------------------|---------|---------------------------------------------------------------------------------------|---------|---------------------------------------------------------------------------------------|---------|--------------------------------------------------------------------------------------|---------|--------------------------------------------------------------------------------------|---------|-------------------------------------------------------------------------------------|---------|-------------------------------------------------------------------------------------|---------|-------------------------------------------------------------------------------------|---------|-------------------------------------------------------------------------------------|---------|-------------------------------------------------------------------------------------|---------|-------------------------------------------------------------------------------------|---------|-------------------------------------------------------------------------------------|---------|-------------------------------------------------------------------------------------|---------|---------------------------------------------------------------------------------------|---------|---------------------------------------------------------------------------------------|---------|---------------------------------------------------------------------------------------|---------|---------------------------------------------------------------------------------------|---------|---------------------------------------------------------------------------------------|---------|---------------------------------------------------------------------------------------|---------|---------------------------------------------------------------------------------------|---------|---------------------------------------------------------------------------------------|---------|---------------------------------------------------------------------------------------|---------|---------------------------------------------------------------------------------------|---------|---------------------------------------------------------------------------------------|---------|---------------------------------------------------------------------------------------|---------|--------------------------------------------------------------------------------------|---------|--------------------------------------------------------------------------------------|---------|-------------------------------------------------------------------------------------|---------|--|
|  | DFN0603 |  | 1CH/UNI |  | DFN1006 |  | 1CH/UNI |  | DFN1006-3L |  | 1CH/UNI |  | DFN1610-6L |  | 1CH/UNI |  | DFN1610 |  | 1CH/UNI |  | DFN2020-3L |  | 1CH/UNI |  | DFN2020-3L |  | 1CH/UNI |  | DFN2510 |  | 1CH/UNI |  | DFN2626-10L |  | 1CH/UNI |  | DFN3810-9L |  | 1CH/UNI |  | SOD-923 |  | 1CH/UNI |  | SOD-523 |  | 2CH/UNI |  | SOD-523 |  | 2CH/UNI |  | SOD-523 |  | 2CH/UNI |  | SOD-523 |  | 2CH/UNI |  | SOD-523 |  | 2CH/UNI |  | SOD-523 |  | 2CH/UNI |  | SOD-523 |  | 2CH/UNI |  | SOD-523 |  | 2CH/UNI |  | SOD-523 |  | 2CH/UNI |  | SOD-523 |  | 2CH/UNI |  | SOD-523 |  | 2CH/UNI |  | SOT-523 |  | 2CH/UNI |  | SOT-323 |  | 2CH/UNI |  | SOT-323 |  | 2CH/UNI |  | SOT-323 |  | 2CH/UNI |  | SOT-323 |  | 2CH/UNI |  | SOT-323 |  | 2CH/UNI |  | SOT-323 |  | 2CH/UNI |  | SOT-323 |  | 2CH/UNI |  | SOT-323 |  | 2CH/UNI |  | SOT-323 |  | 2CH/UNI |  | SOT-323 |  | 2CH/UNI |  | SOT-363 |  | 2CH/UNI |  | SOT-143 |  | 2CH/UNI |  | SOT-143 |  | 2CH/UNI |  | SOT-143 |  | 2CH/UNI |  | SOT-143 |  | 2CH/UNI |  | SOT-23-6L |  | 2CH/UNI |  | SOT-23 |  | 2CH/UNI |  | SOT-23 |  | 2CH/UNI |  | SOT-23 |  | 2CH/UNI |  | SOT-23 |  | 2CH/UNI |  | SOT-23 |  | 2CH/UNI |  | SOT-323 |  | 2CH/UNI |  | SOT-323 |  | 2CH/UNI |  | SOT-323 |  | 2CH/UNI |  | SOT-323 |  | 2CH/UNI |  | SOT-323 |  | 2CH/UNI |  | SOT-323 |  | 2CH/UNI |  | SOT-323 |  | 2CH/UNI |  | SOT-323 |  | 2CH/UNI |  | SOT-323 |  | 2CH/UNI |  | SOT-323 |  | 2CH/UNI |  | SOT-323 |  | 2CH/UNI |  | SOT-363 |  | 2CH/UNI |  | SOT-123 |  | 2CH/UNI |  | SOT-123 |  | 2CH/UNI |  | SOT-123 |  | 2CH/UNI |  | SOT-123 |  | 2CH/UNI |  | SOT-123 |  | 2CH/UNI |  | SOT-123 |  | 2CH/UNI |  | SOT-123 |  | 2CH/UNI |  | SOT-123 |  | 2CH/UNI |  | SOT-123 |  | 2CH/UNI |  | SOT-123 |  | 2CH/UNI |  | SOT-143 |  | 2CH/UNI |  | SOT-143 |  | 2CH/UNI |  | SOT-143 |  | 2CH/UNI |  | SOT-143 |  | 2CH/UNI |  | SOT-143 |  | 2CH/UNI |  | SOT-143 |  | 2CH/UNI |  | SOT-143 |  | 2CH/UNI |  | SOT-143 |  | 2CH/UNI |  | SOT-143 |  | 2CH/UNI |  | SOT-143 |  | 2CH/UNI |  | SOT-143 |  | 2CH/UNI |  | SOT-23 |  | 2CH/UNI |  | SOT-23 |  | 2CH/UNI |  | SOT-23 |  | 2CH/UNI |  | SOT-23 |  | 2CH/UNI |  | SOT-23 |  | 2CH/UNI |  | SOT-23 |  | 2CH/UNI |  | SOT-23 |  | 2CH/UNI |  | SOT-23 |  | 2CH/UNI |  | SOT-23 |  | 2CH/UNI |  | SOT-23 |  | 2CH/UNI |  | SOT-23 |  | 2CH/UNI |  | SOT-363 |  | 2CH/UNI |  | SOT-363 |  | 2CH/UNI |  | SOT-363 |  | 2CH/UNI |  | SOT-363 |  | 2CH/UNI |  | SOT-363 |  | 2CH/UNI |  | SOT-363 |  | 2CH/UNI |  | SOT-363 |  | 2CH/UNI |  | SOT-363 |  | 2CH/UNI |  | SOT-363 |  | 2CH/UNI |  | SOT-363 |  | 2CH/UNI |  | SOT-363 |  | 2CH/UNI |  | SOT-423 |  | 2CH/UNI |  | SOT-423 |  | 2CH/UNI |  | SOT-423 |  | 2CH/UNI |  | SOT-423 |  | 2CH/UNI |  | SOT-423 |  | 2CH/UNI |  | SOT-423 |  | 2CH/UNI |  | SOT-423 |  | 2CH/UNI |  | SOT-423 |  | 2CH/UNI |  | SOT-423 |  | 2CH/UNI |  | SOT-423 |  | 2CH/UNI |  | SOT-423 |  | 2CH/UNI |  | SOT-423 |  | 2CH/UNI |  | SOT-423 |  | 2CH/UNI |  | SOT-423 |  | 2CH/UNI |  | SOT-423 |  | 2CH/UNI |  | SOT-423 |  | 2CH/UNI |  | SOT-423 |  | 2CH/UNI |  | SOT-423 |  | 2CH/UNI |  | SOT-423 |  | 2CH/UNI |  | SOT-423 |  | 2CH/UNI |  | SOT-423 |  | 2CH/UNI |  | SOT-423 |  | 2CH/UNI |  | SOT-423 |  | 2CH/UNI |  | SOT-423 |  | 2CH/UNI |  | SOT-423 |  | 2CH/UNI |  | SOT-423 |  | 2CH/UNI |  | SOT-423 |  | 2CH/UNI |  | SOT-423 |  | 2CH/UNI |  | SOT-423 |  | 2CH/UNI |  | SOT-423 |  |
|-------------------------------------------------------------------------------------|---------|-------------------------------------------------------------------------------------|---------|-------------------------------------------------------------------------------------|---------|-------------------------------------------------------------------------------------|---------|-------------------------------------------------------------------------------------|------------|-------------------------------------------------------------------------------------|---------|-------------------------------------------------------------------------------------|------------|-------------------------------------------------------------------------------------|---------|-------------------------------------------------------------------------------------|---------|-------------------------------------------------------------------------------------|---------|-------------------------------------------------------------------------------------|------------|-------------------------------------------------------------------------------------|---------|------------------------------------------------------------------------------------|------------|------------------------------------------------------------------------------------|---------|-----------------------------------------------------------------------------------|---------|-----------------------------------------------------------------------------------|---------|-----------------------------------------------------------------------------------|-------------|-----------------------------------------------------------------------------------|---------|-----------------------------------------------------------------------------------|------------|-----------------------------------------------------------------------------------|---------|-----------------------------------------------------------------------------------|---------|-----------------------------------------------------------------------------------|---------|-------------------------------------------------------------------------------------|---------|-------------------------------------------------------------------------------------|---------|-------------------------------------------------------------------------------------|---------|-------------------------------------------------------------------------------------|---------|-------------------------------------------------------------------------------------|---------|-------------------------------------------------------------------------------------|---------|-------------------------------------------------------------------------------------|---------|-------------------------------------------------------------------------------------|---------|-------------------------------------------------------------------------------------|---------|-------------------------------------------------------------------------------------|---------|-------------------------------------------------------------------------------------|---------|-------------------------------------------------------------------------------------|---------|------------------------------------------------------------------------------------|---------|------------------------------------------------------------------------------------|---------|-----------------------------------------------------------------------------------|---------|-----------------------------------------------------------------------------------|---------|-----------------------------------------------------------------------------------|---------|-----------------------------------------------------------------------------------|---------|-----------------------------------------------------------------------------------|---------|-----------------------------------------------------------------------------------|---------|-----------------------------------------------------------------------------------|---------|-----------------------------------------------------------------------------------|---------|-------------------------------------------------------------------------------------|---------|-------------------------------------------------------------------------------------|---------|-------------------------------------------------------------------------------------|---------|-------------------------------------------------------------------------------------|---------|-------------------------------------------------------------------------------------|---------|-------------------------------------------------------------------------------------|---------|-------------------------------------------------------------------------------------|---------|-------------------------------------------------------------------------------------|---------|-------------------------------------------------------------------------------------|---------|-------------------------------------------------------------------------------------|---------|-------------------------------------------------------------------------------------|---------|-------------------------------------------------------------------------------------|---------|------------------------------------------------------------------------------------|---------|------------------------------------------------------------------------------------|---------|-----------------------------------------------------------------------------------|---------|-----------------------------------------------------------------------------------|---------|-----------------------------------------------------------------------------------|---------|-----------------------------------------------------------------------------------|---------|-----------------------------------------------------------------------------------|---------|-----------------------------------------------------------------------------------|---------|-----------------------------------------------------------------------------------|---------|-----------------------------------------------------------------------------------|---------|---------------------------------------------------------------------------------------|---------|---------------------------------------------------------------------------------------|---------|---------------------------------------------------------------------------------------|---------|---------------------------------------------------------------------------------------|---------|---------------------------------------------------------------------------------------|---------|---------------------------------------------------------------------------------------|---------|---------------------------------------------------------------------------------------|---------|---------------------------------------------------------------------------------------|---------|---------------------------------------------------------------------------------------|---------|---------------------------------------------------------------------------------------|---------|---------------------------------------------------------------------------------------|-----------|---------------------------------------------------------------------------------------|---------|--------------------------------------------------------------------------------------|--------|--------------------------------------------------------------------------------------|---------|-------------------------------------------------------------------------------------|--------|-------------------------------------------------------------------------------------|---------|-------------------------------------------------------------------------------------|--------|-------------------------------------------------------------------------------------|---------|-------------------------------------------------------------------------------------|--------|-------------------------------------------------------------------------------------|---------|-------------------------------------------------------------------------------------|--------|-------------------------------------------------------------------------------------|---------|---------------------------------------------------------------------------------------|---------|---------------------------------------------------------------------------------------|---------|---------------------------------------------------------------------------------------|---------|---------------------------------------------------------------------------------------|---------|---------------------------------------------------------------------------------------|---------|---------------------------------------------------------------------------------------|---------|---------------------------------------------------------------------------------------|---------|---------------------------------------------------------------------------------------|---------|---------------------------------------------------------------------------------------|---------|---------------------------------------------------------------------------------------|---------|---------------------------------------------------------------------------------------|---------|---------------------------------------------------------------------------------------|---------|--------------------------------------------------------------------------------------|---------|--------------------------------------------------------------------------------------|---------|-------------------------------------------------------------------------------------|---------|-------------------------------------------------------------------------------------|---------|-------------------------------------------------------------------------------------|---------|-------------------------------------------------------------------------------------|---------|-------------------------------------------------------------------------------------|---------|-------------------------------------------------------------------------------------|---------|-------------------------------------------------------------------------------------|---------|-------------------------------------------------------------------------------------|---------|---------------------------------------------------------------------------------------|---------|---------------------------------------------------------------------------------------|---------|---------------------------------------------------------------------------------------|---------|---------------------------------------------------------------------------------------|---------|---------------------------------------------------------------------------------------|---------|---------------------------------------------------------------------------------------|---------|---------------------------------------------------------------------------------------|---------|---------------------------------------------------------------------------------------|---------|---------------------------------------------------------------------------------------|---------|---------------------------------------------------------------------------------------|---------|---------------------------------------------------------------------------------------|---------|---------------------------------------------------------------------------------------|---------|--------------------------------------------------------------------------------------|---------|--------------------------------------------------------------------------------------|---------|-------------------------------------------------------------------------------------|---------|-------------------------------------------------------------------------------------|---------|-------------------------------------------------------------------------------------|---------|-------------------------------------------------------------------------------------|---------|-------------------------------------------------------------------------------------|---------|-------------------------------------------------------------------------------------|---------|-------------------------------------------------------------------------------------|---------|-------------------------------------------------------------------------------------|---------|---------------------------------------------------------------------------------------|---------|---------------------------------------------------------------------------------------|---------|---------------------------------------------------------------------------------------|---------|---------------------------------------------------------------------------------------|---------|---------------------------------------------------------------------------------------|---------|---------------------------------------------------------------------------------------|---------|---------------------------------------------------------------------------------------|---------|---------------------------------------------------------------------------------------|---------|---------------------------------------------------------------------------------------|---------|---------------------------------------------------------------------------------------|---------|---------------------------------------------------------------------------------------|---------|---------------------------------------------------------------------------------------|---------|--------------------------------------------------------------------------------------|---------|--------------------------------------------------------------------------------------|---------|-------------------------------------------------------------------------------------|---------|-------------------------------------------------------------------------------------|---------|-------------------------------------------------------------------------------------|---------|-------------------------------------------------------------------------------------|---------|-------------------------------------------------------------------------------------|---------|-------------------------------------------------------------------------------------|---------|-------------------------------------------------------------------------------------|---------|-------------------------------------------------------------------------------------|---------|---------------------------------------------------------------------------------------|--------|---------------------------------------------------------------------------------------|---------|---------------------------------------------------------------------------------------|--------|---------------------------------------------------------------------------------------|---------|---------------------------------------------------------------------------------------|--------|---------------------------------------------------------------------------------------|---------|---------------------------------------------------------------------------------------|--------|---------------------------------------------------------------------------------------|---------|---------------------------------------------------------------------------------------|--------|---------------------------------------------------------------------------------------|---------|---------------------------------------------------------------------------------------|--------|---------------------------------------------------------------------------------------|---------|--------------------------------------------------------------------------------------|--------|--------------------------------------------------------------------------------------|---------|-------------------------------------------------------------------------------------|--------|-------------------------------------------------------------------------------------|---------|-------------------------------------------------------------------------------------|--------|-------------------------------------------------------------------------------------|---------|-------------------------------------------------------------------------------------|--------|-------------------------------------------------------------------------------------|---------|-------------------------------------------------------------------------------------|--------|-------------------------------------------------------------------------------------|---------|---------------------------------------------------------------------------------------|---------|---------------------------------------------------------------------------------------|---------|---------------------------------------------------------------------------------------|---------|---------------------------------------------------------------------------------------|---------|---------------------------------------------------------------------------------------|---------|---------------------------------------------------------------------------------------|---------|---------------------------------------------------------------------------------------|---------|---------------------------------------------------------------------------------------|---------|---------------------------------------------------------------------------------------|---------|---------------------------------------------------------------------------------------|---------|---------------------------------------------------------------------------------------|---------|---------------------------------------------------------------------------------------|---------|--------------------------------------------------------------------------------------|---------|--------------------------------------------------------------------------------------|---------|-------------------------------------------------------------------------------------|---------|-------------------------------------------------------------------------------------|---------|-------------------------------------------------------------------------------------|---------|-------------------------------------------------------------------------------------|---------|-------------------------------------------------------------------------------------|---------|-------------------------------------------------------------------------------------|---------|-------------------------------------------------------------------------------------|---------|-------------------------------------------------------------------------------------|---------|---------------------------------------------------------------------------------------|---------|---------------------------------------------------------------------------------------|---------|---------------------------------------------------------------------------------------|---------|---------------------------------------------------------------------------------------|---------|---------------------------------------------------------------------------------------|---------|---------------------------------------------------------------------------------------|---------|---------------------------------------------------------------------------------------|---------|---------------------------------------------------------------------------------------|---------|---------------------------------------------------------------------------------------|---------|---------------------------------------------------------------------------------------|---------|---------------------------------------------------------------------------------------|---------|---------------------------------------------------------------------------------------|---------|--------------------------------------------------------------------------------------|---------|--------------------------------------------------------------------------------------|---------|-------------------------------------------------------------------------------------|---------|-------------------------------------------------------------------------------------|---------|-------------------------------------------------------------------------------------|---------|-------------------------------------------------------------------------------------|---------|-------------------------------------------------------------------------------------|---------|-------------------------------------------------------------------------------------|---------|-------------------------------------------------------------------------------------|---------|-------------------------------------------------------------------------------------|---------|---------------------------------------------------------------------------------------|---------|---------------------------------------------------------------------------------------|---------|---------------------------------------------------------------------------------------|---------|---------------------------------------------------------------------------------------|---------|---------------------------------------------------------------------------------------|---------|---------------------------------------------------------------------------------------|---------|---------------------------------------------------------------------------------------|---------|---------------------------------------------------------------------------------------|---------|---------------------------------------------------------------------------------------|---------|---------------------------------------------------------------------------------------|---------|---------------------------------------------------------------------------------------|---------|---------------------------------------------------------------------------------------|---------|--------------------------------------------------------------------------------------|---------|--------------------------------------------------------------------------------------|---------|-------------------------------------------------------------------------------------|---------|-------------------------------------------------------------------------------------|---------|-------------------------------------------------------------------------------------|---------|-------------------------------------------------------------------------------------|---------|-------------------------------------------------------------------------------------|---------|-------------------------------------------------------------------------------------|---------|-------------------------------------------------------------------------------------|---------|-------------------------------------------------------------------------------------|---------|---------------------------------------------------------------------------------------|---------|---------------------------------------------------------------------------------------|---------|---------------------------------------------------------------------------------------|---------|---------------------------------------------------------------------------------------|---------|---------------------------------------------------------------------------------------|---------|---------------------------------------------------------------------------------------|---------|---------------------------------------------------------------------------------------|---------|---------------------------------------------------------------------------------------|---------|---------------------------------------------------------------------------------------|---------|---------------------------------------------------------------------------------------|---------|---------------------------------------------------------------------------------------|---------|---------------------------------------------------------------------------------------|---------|--------------------------------------------------------------------------------------|---------|--------------------------------------------------------------------------------------|---------|-------------------------------------------------------------------------------------|---------|--|